

# Hunter

stoves



SUPERIOR CHOICE  
Heating Solutions

# Contents

---

Inspired by the past,  
ready for the future...

---

Herald 8	Page 1
Herald 14	Page 2
Inglenook High Output	Page 3
Double Sided Herald 8	Page 4
Double Sided Herald 14	Page 5
Telford Inset Boiler 20B	Page 6
Herald 8 Boiler Stoves	Page 7
Herald 14 Boiler Stoves	Page 8
80B Boiler Stoves	Page 9
Range / Options	Page 10-11
Technical Key/ Warranty / FAQs	Page 12-13



# Herald 8

HEATING SOLUTIONS



Its warming toes all over the world, the Herald 8 is one of our best sellers and at 78.9% it's incredibly efficient for its size. Complete with our Cleanburn and Tripleburn technology you can rest easy knowing your Herald 8 will be working hard getting as much value as possible out of every piece of fuel you use. Good looks, tried and tested technology and incredible value for money? What else could you possibly need?



Heat Output Range – 6kW – 11kW

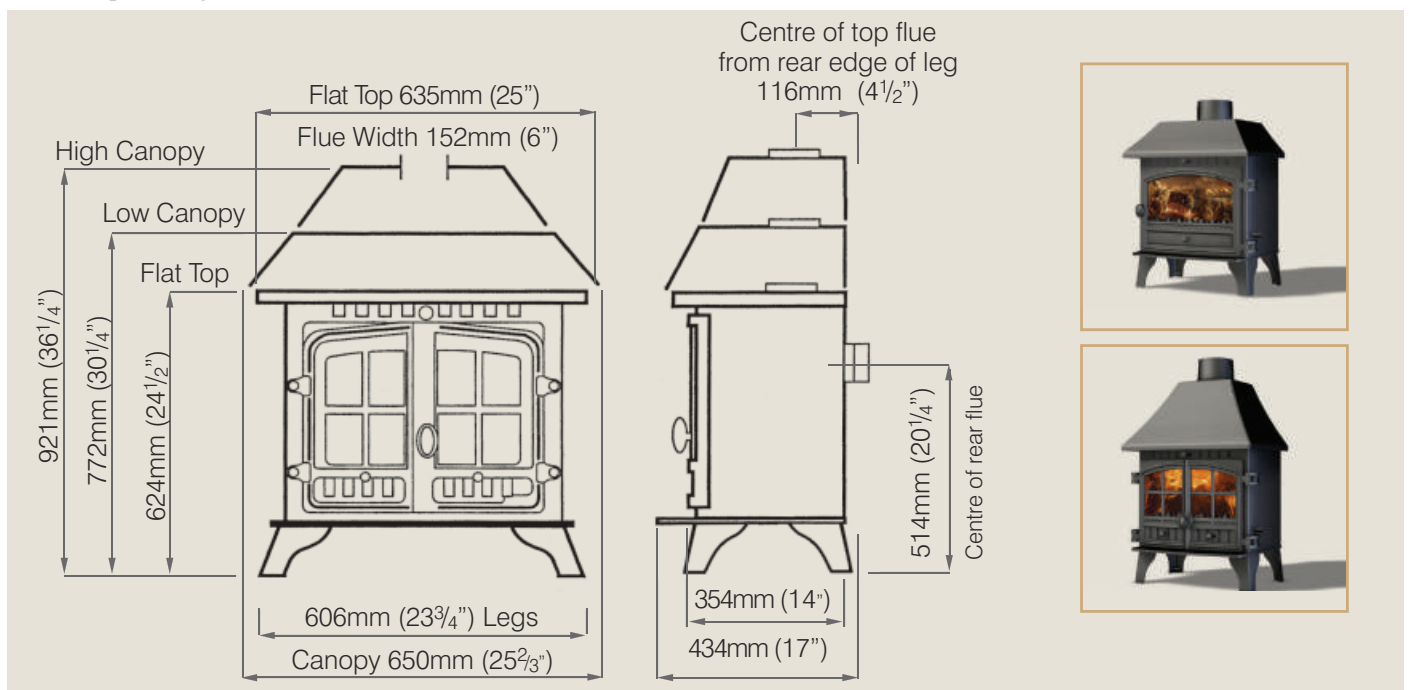

# Herald 14



A real fire can create quite the atmosphere but this used to come at an awfully high environmental cost – not any more. With a fantastic 78.6% efficiency our Herald 14 will elevate your carbon conscience. With our frequently imitated and never replicated Cleanburn technology you can load up the large firebed with your chosen fuel and be confident that your Herald 14 will burn away happily on its own needing minimum attention but giving maximum output.



Heat Output Range – 8kW – 15kW

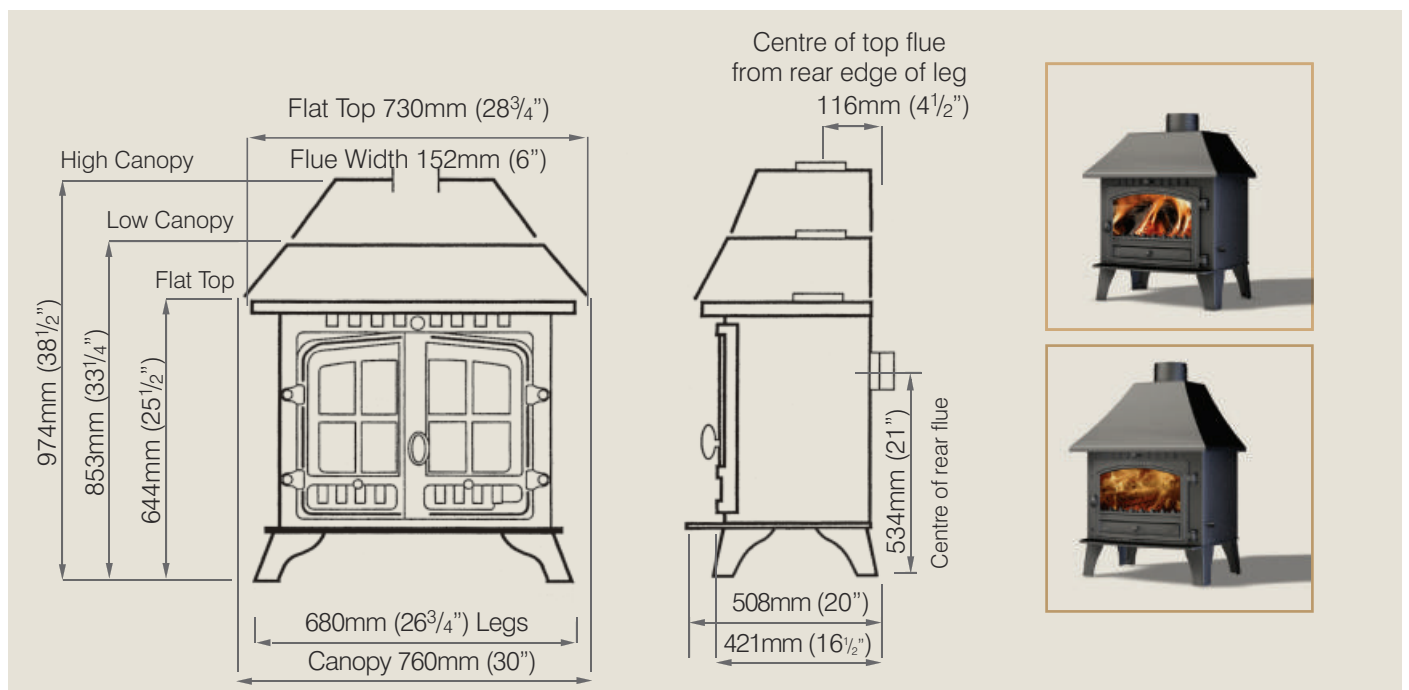

# Inglenook High Output

HEATING SOLUTIONS



Our immense Inglenook High Output stove is perfect for the rooms on the larger side, giving a maximum output of 20 kW that's enough to heat the coldest of chambers. For the large fireplaces add the inglenook canopy for a striking feature that's bound to impress, but there is more behind the pleasing aesthetics; with our dependable technologies working behind the scenes you'll be safe in the knowledge that your Inglenook is taking care of your heating needs whilst taking pride of place in your living space.



Heat Output Range – 8kW – 20kW

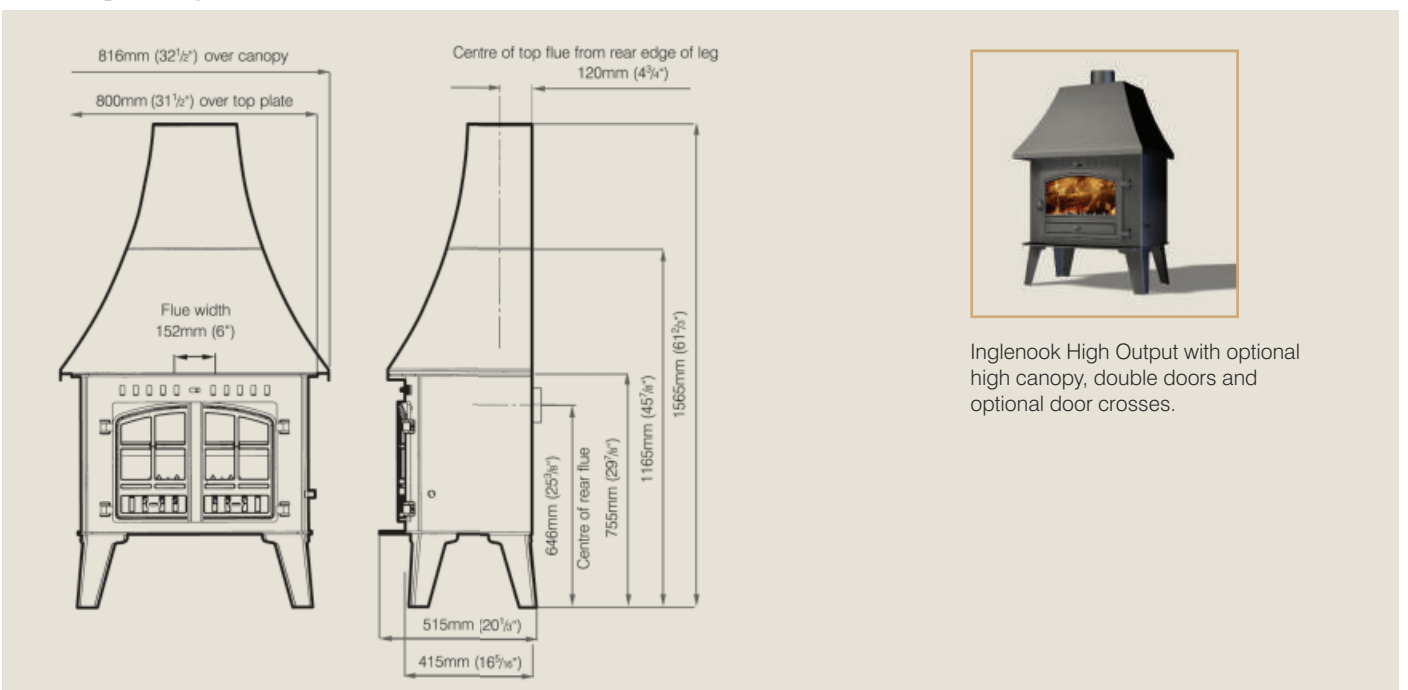

Inglenook High Output with optional high canopy, double doors and optional door crosses.

# Herald 8

Double Sided



Enjoy twice the cosiness and twice the comforting view of your new fire. The Herald 8 Double Sided is designed either to open in adjacent rooms to heat both using the same fuel load or to give a striking focal point in your open plan living space. Either way the Herald 8 Double Sided provides exceptional heat for minimum fuel thanks to our remarkable Triple Burn technology.



Herald 8 Double Single - Heat Output Range - 6kW - 11kW  
 Herald 8 Double Double - Heat Output Range - 8kW - 18kW

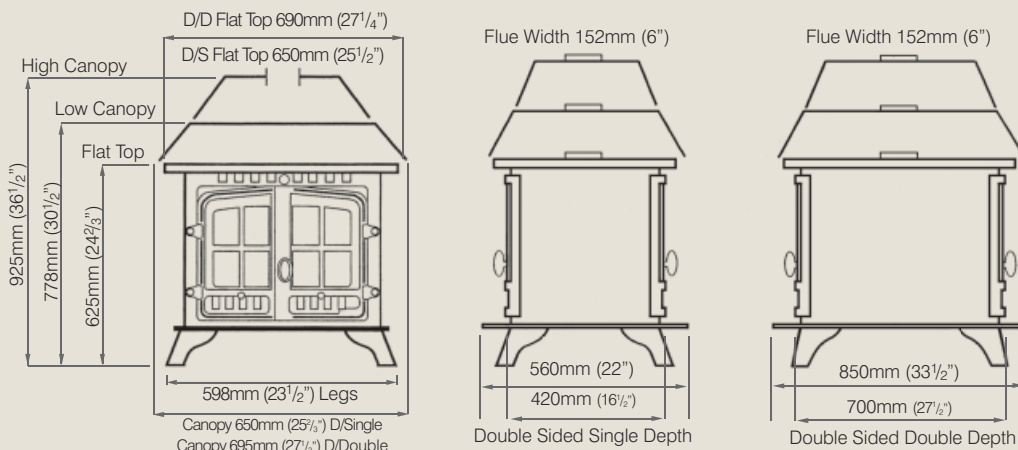

# Herald 14

Double Sided

HEATING SOLUTIONS



Bring life into your open plan living. The Herald 14 double sided radiates heat 360° to warm the biggest rooms and creates a stunning focal point. Don't worry about having to choose size over quality because the Herald 14 delivers both in spades. Complete with our Tripleburn Technology to warm you quickly and effectively and our Hot Air Wash to keep your glass clean and clear. The only thing you need to worry about is allowing your new Herald 14 to keep you warm as the nights draw in.



Herald 14 Double Single - Heat Output Range – 8kW – 15kW  
 Herald 14 Double Double - Heat Output Range – 14kW – 25kW

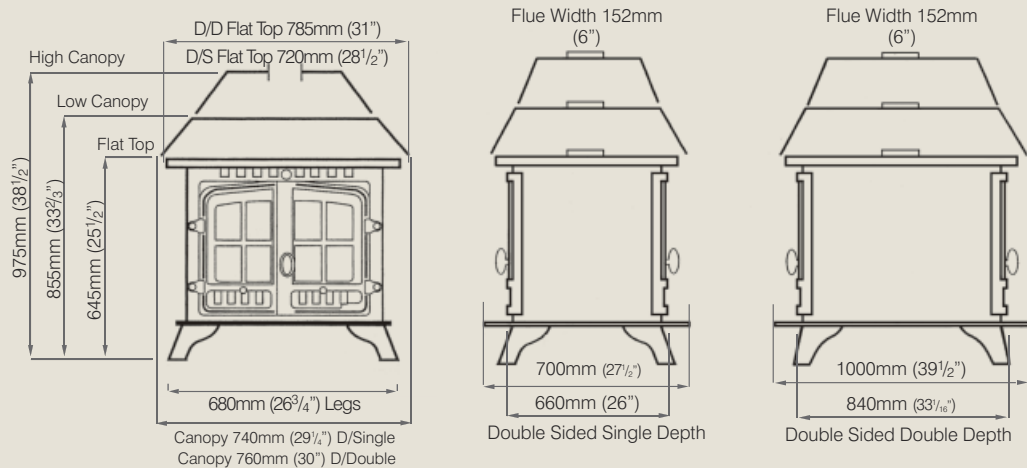

# Telford 20<sup>B</sup> Boiler Stove



If your central heating system is out-dated, uninviting or getting in the way of your everyday life then our new Telford Central Heating stove is the solution. Instead of a space consuming boiler a stunning inset fire drives your central heating and what's more comforting than real flames? With an impressive 10.4 kW boiler and a cosy 5.1 kW to your room it's guaranteed to keep you snug all winter long.

## Wraparound Boiler

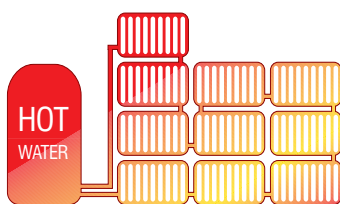

Output to water	Output to room
<b>10.7kW</b>	<b>5.1kW</b>
Maximum output	
<b>12kW (41,000 BTU)</b>	<b>6kW</b>

Nominal\* output when burning smokeless fuel

**10.7kW**      **5.1kW**

Maximum output

**12kW (41,000 BTU)**      **6kW**

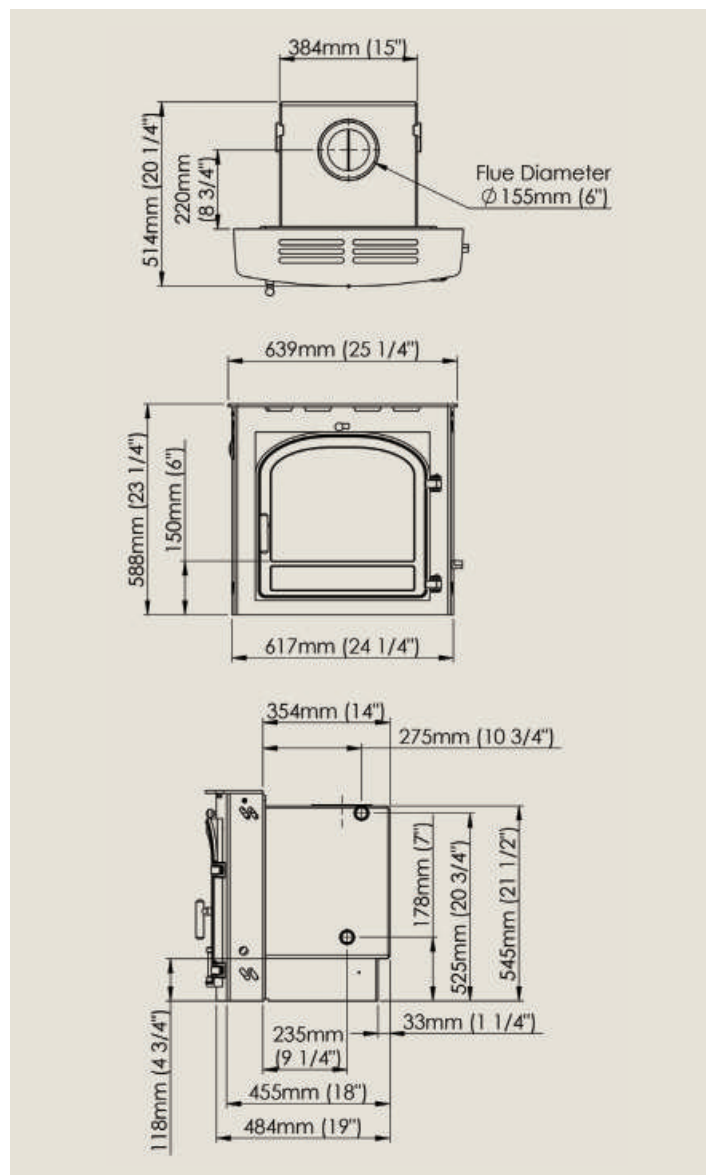





Not only able to warm your room the Herald 8 with a boiler is able to heat your entire house and hot water. With our Triple Burn technology making sure as much energy from your fuel as possible is being used to warm your home. Flames are mesmerising and thanks to our Hot Air Wash keeping the glass clean and clear you'll be able to watch your Herald 8 hard at work.

### Wraparound Boiler

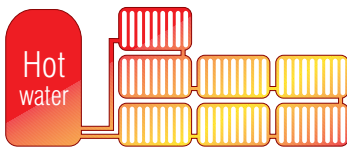

Output to water	Output to room
Nominal* output when burning wood	
6.4kW	2.2kW
Nominal* output when burning smokeless fuel	
6.3kW	1.7kW
Maximum output	
8.5kW (29,000 BTU)	2.5kW

### Clip-in Boiler



Output to water	Output to room
Nominal* output when burning wood or smokeless fuel	
5.0kW	1.5kW
Maximum output	
5.5kW (18,750 BTU)	2.5kW

Number of radiators is dependent on size  
\*Nominal = the minimum achievable heat output

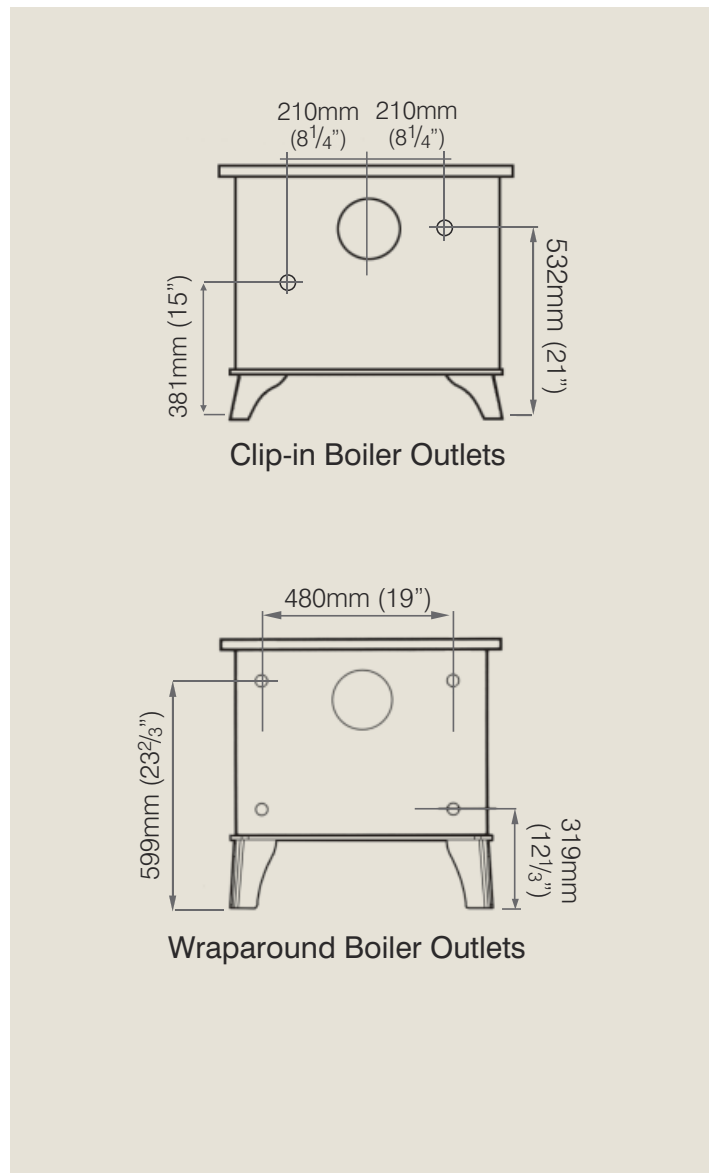

# Herald 14

Boiler Stove



Home is where the hearth is and there is nothing better than curling up in front of a warm fire of an evening, unless it's also knowing your fire is warming your entire house as well. Fill the generous firebox with your chosen fuel and watch as the Herald 14's amazing Tripleburn technology works its magic. All you have to do is sit back, relax and enjoy!

## Wraparound Boiler

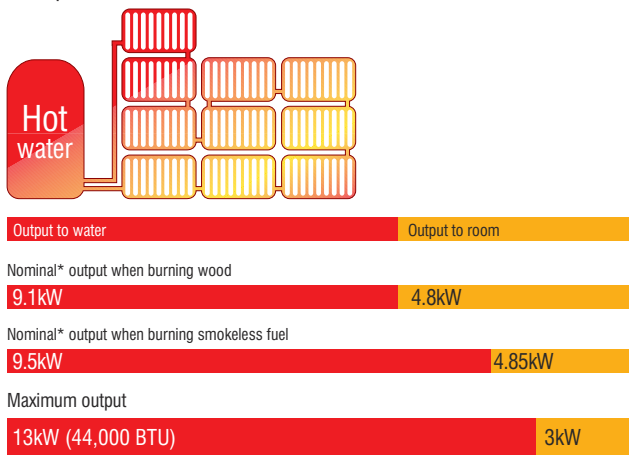

## Clip-in Boiler

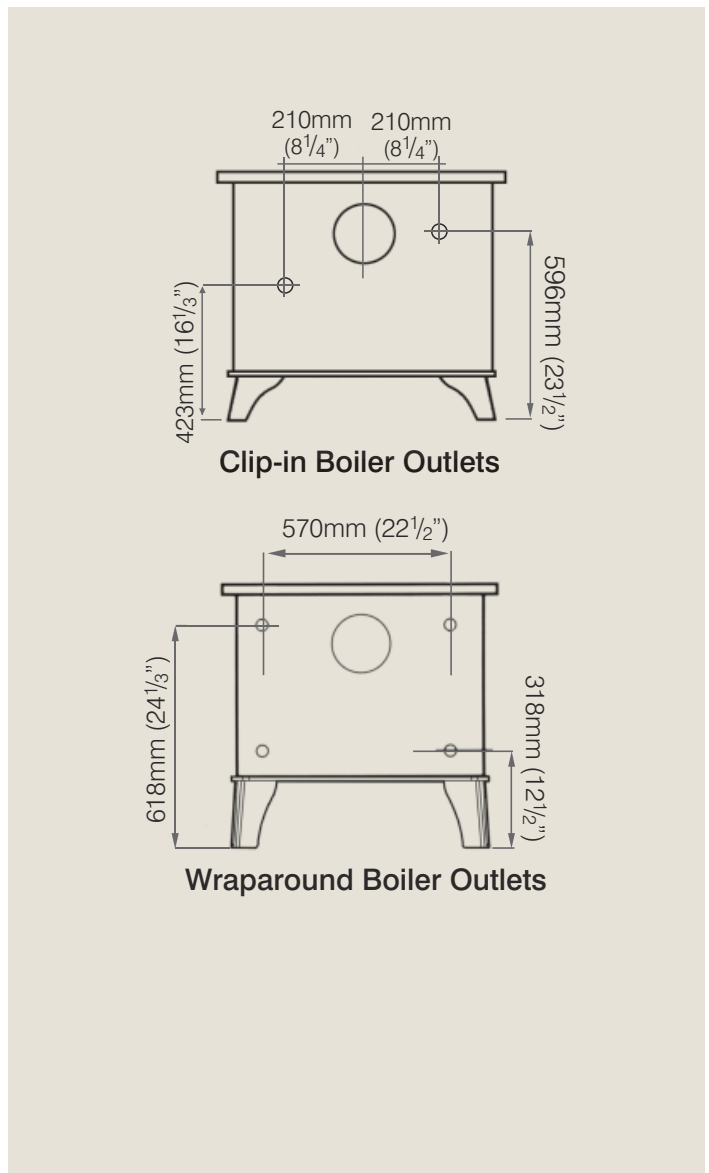
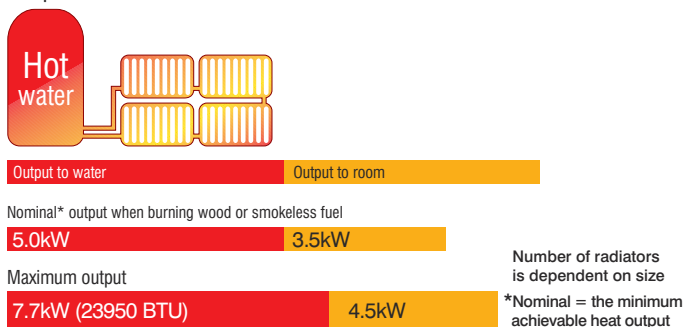

# Herald 80<sup>B</sup> Boiler Stove

HEATING SOLUTIONS



You'll never be cold again with our Hunter 80B running your central heating. It's our most powerful boiler yet. It's been designed to run up to 15 radiators and your hot water. Not only will you be benefiting from cheaper heating bills but you will get all of our tried and tested technology; Cleanburn and Tripleburn technologies make sure the 80B is as economical and eco-friendly as possible and you won't even have to lift a finger to keep the glass clean as our Hot Air Wash will do that for you.

## Wraparound Boiler

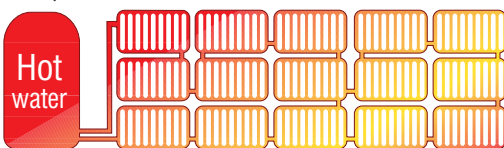

Number of radiators is dependent on size

Output to water	Output to room
Nominal* output when burning wood <b>12.4kW</b>	<b>9.1kW</b>
Nominal* output when burning smokeless fuel <b>12.5kW</b>	<b>4.5kW</b>
Maximum output <b>16kW (54,600 BTU)</b>	<b>10kW</b>

\*Nominal = the minimum achievable heat output

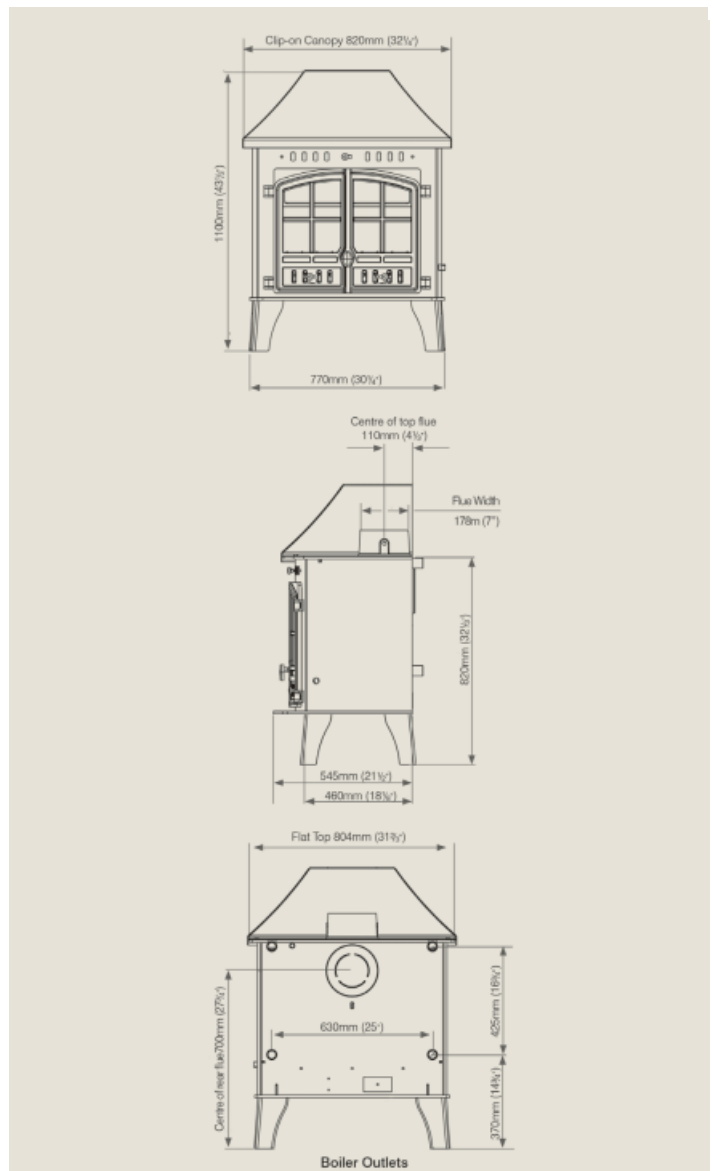

# The Superior Range

---

## CE Tested and Approved

All the stoves in the Hunter Superior Choice range meet the stringent CE approval test requirements.

## New Hunter Cleanburn Technology

Cleanburn technology means that more of the fuel is ignited, resulting in an increased heat output, less smoke, and a cleaner environment.

## Exceptionally Efficient

Currents of air inside the stove ensure that fuel is burnt evenly and efficiently.

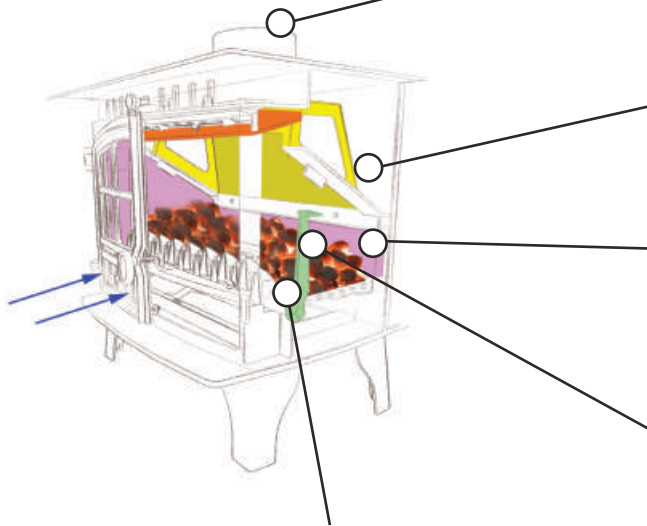

## From Wood to Multi-Fuel with a Single Movement of the Tool

The stove's integral grate can be changed from wood to multi-fuel setting with a single movement of the cool - handled riddling tool.

## Safe and Efficient for Over-Night Burning

By reducing the air inflow to an absolute minimum, you can keep the fire gently smouldering overnight. Come morning, increase the air flow and the fire will return to life.

## Dust Free, Safe and Easy Riddling

The riddling tool enables you to clean the grate without causing clouds of dust. Just move it back and forth with the doors closed.

## Interchangeable Flue Outlets

All of the stoves in the Hunter Superior Choice range can be flued from either the top or the rear of the stove.

## Easy Access for Chimney Sweeping \*

Every stove features a removable throat-plate, giving full and easy access for sweeping the chimney.

## Internal Lining System

The new internal lining system maximises the firebox temperature, ensuring complete combustion.

## Cold-handled Riddling Tool

The cold-handled riddling tool can be used for opening and closing the doors, riddling the grate, grate adjustment and easy removal of the ash-pan.

NB.

## Central Heating Stoves

Central heating stoves have no internal lining system

\* This is not possible if a clip in boiler is fitted

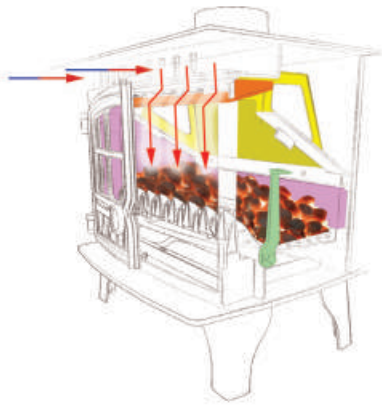

### No need to scrub the glass door

Our innovative airwash draws air from the top of the stove, heats it up in the central air chamber and then sends it down behind the glass door, creating a screen between the fire and the glass. Smoke or combustion particles do not come into contact with the glass, so you don't need to clean it.

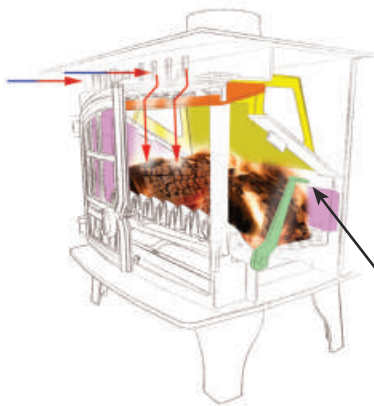

### Optimum Woodburning Conditions

Three streams of hot air ensure that fuel is burned efficiently by maximising combustion. For wood, close the grate and allow a deep bed of ash to build up - the optimum conditions for combustion.

Grate in 'back'  
closed position  
for burning wood

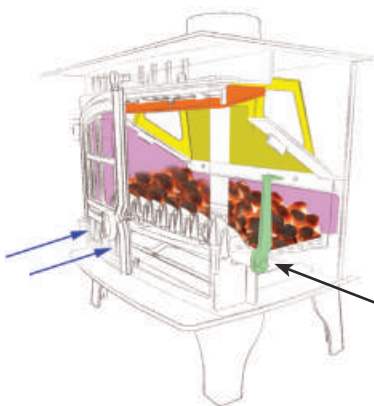

### Optimum Solid Fuel Burning Conditions

When you're burning smokeless fuel, just switch the grate to the open position. Air flows beneath the grate and into the heart of the fire - the optimum conditions for burning solid fuel.

Grate in 'forward'  
open position for  
burning solid fuel

All the Herald stoves are manufactured from high quality 5mm thick steel and have cast iron components.

# Technical Key

Optional spark guard  
(Double door only)

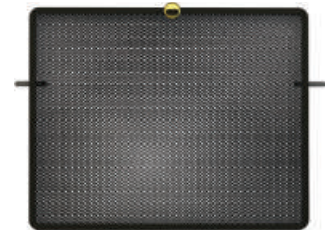

	Herald 8	Herald 14	Inglenook	Herald 8	Herald 8	Herald 14
	Room Heater	Room Heater	Room Heater	Double single	Double Double	Double single
<b>Heat output range to room</b>	<b>6 - 11kW</b>	<b>8 - 15kW</b>	<b>8 - 20kW</b>	<b>6 - 11kW</b>	<b>8 - 18kW</b>	<b>8 - 15kW</b>
Efficiency on wood	78.9%	78.6%	78.4%	74.3%	79%	75.7%
CO Emissions on wood	0.38%	0.57%	0.40%	0.70%	0.36%	0.44%
Nominal output	9.1kW	11.9kW	10.2kW	8.9kW	11.5kW	12.5kW
Low Canopy option	•	•	•	•	•	•
High Canopy Option	•	•	•	•	•	•
Double door option	✓	✓	✓	✓	✓	✓
Single door option	•	•	•	•	•	•
Wood Burning only*	•	•	•	•	•	•
Cross Kit Double Door only	•	•	•	•	•	•
Brass Knob	•	•	•	•	•	•
Flue Damper	•	•	•	•	•	•
Multi fuel Extention	•	•	•	•	•	•
Sparkguard (double door only)	•	•	•	•	•	•
Flue Gather Box	•	•	•	~	~	~
Ventilation	2255 mm <sup>2</sup>	3795 mm <sup>2</sup>	2860 mm <sup>2</sup>	2145 mm <sup>2</sup>	3520 mm <sup>2</sup>	4565 mm <sup>2</sup>
Leg lengths	6" - 152mm	7" - 178mm	9 1/4 - 235mm	6" - 152mm	6" - 152mm	7" - 178mm
Log length (approx)	19 3/4 - 500mm	19 3/4 - 500mm	19 3/4 - 500mm	19 3/4 - 500mm	19 3/4 - 500mm	19 3/4 - 500mm
Weight (flat top, multifuel)	120 kg	145 kg	160 kg	140 kg	230 kg	165 kg

\*All stoves are multifuel as standard

## Hunter Warranty

All Hunter Stoves now come with a 2-5 year warranty. This is only valid if the stoves are serviced annually on the anniversary of installation. For details of the warranty specifications please visit our website [www.hunterstoves.co.uk](http://www.hunterstoves.co.uk) for full Terms and Conditions.



Heat outputs are dependent on fuel load and installation parameters. Overnight burning is dependent on fire box size, fuel load etc. Many thanks to B D Brooks Fireplaces, BWF Humphries, Focus Fireplaces for the provision of fireplaces/photography. Hunter Stoves Limited has a policy of continuous product improvement and therefore reserves the right to change specifications and designs at any time without prior notice.

Hunter Stoves Ltd. strongly recommends that the suitability of any installation should firstly be agreed with a HETAS qualified installer or similarly competent professional, to ensure compliance with the recent changes to the Building Regulations. Hunter Stoves Ltd. will not be held responsible for any losses, however arising, from inappropriate installations by unqualified or non-competent installers. An inappropriate installation may also invalidate claims made under a manufacturer's warranty or guarantee. NB. Please note that all weights are approximate and could vary slightly.



Optional flue gather box, for rear flue installations and limited space installations



Optional flue damper

Herald 14	Telford 20B	Herald 8	Herald 14	Hunter 80B
Double Double	Central Heating (41000btu boiler)	Central Heating (29000btu boiler)	Central Heating (44000btu boiler)	Central Heating (54,600btu boiler)
<b>14 - 25kW</b>	<b>5kW-6kW</b>	<b>1.7 - 2.2kW</b>	<b>3 - 4.8kW</b>	<b>4.5 - 10kW</b>
71.1%	69.9%	73.4%	73.6%	71%
0.35%	0.33%	0.52%	0.50%	0.38%
17.8kW	15.8 kW	8.6kW	14.3kW	21.5kW
•	~	•	•	•
•	~	•	•	~
√	~	√	√	√
•	√	•	•	~
•	~	•	•	•
•	~	•	•	•
•	~	•	•	•
•	~	•	•	•
•	~	•	•	•
•	~	•	•	~
~	~	•	•	~
7040 mm <sup>2</sup>	5940 mm <sup>2</sup>	1980 mm <sup>2</sup>	5115 mm <sup>2</sup>	9075 mm <sup>2</sup>
7" - 178mm	6" - 152 mm	6" - 152mm	7" - 178mm	8" - 200mm
19 3/4 - 500mm	19 3/4 - 500mm	19 3/4 - 500mm	19 3/4 - 500mm	21" - 533mm
270 kg	128 kg	133 kg	163 kg	218 kg



√ = standard

• = option

~ = not available

1. Boiler output, see page 20

NB Ventilation is dependent on the permeability rating of the building. For further details please visit:

<http://www.planningportal.gov.uk/buildingregulations/approveddocuments/parti/approved>

and download the free copy of Document J. Info about the ventilation and air permeability ratings is table 1 on page 29.



## FAQs

### HOW MUCH SPACE WILL MY STOVE NEED?

With all our freestanding units it is safe to install with a clearance of 2" (50mm) either side and above the stove to NON Combustible material. However for optimum performance and heat output we recommend a clearance of 6" (150mm). Behind the stove there should be a minimum clearance of 2" (50mm) however we recommend 4" (100mm) to enable access to the Tertiary Air inlet.

For all our units the hearth should extend 300mm in front of the appliance (from the door opening)

### WHAT IS A NOMINAL HEAT OUTPUT?

The nominal output is the output achieved under specific test conditions by the independent test laboratory. The stoves tend to be operated with the air controls set at less than maximum and with relatively modest fuel loads. We recognise that end users are unlikely to operate the stoves in this way and therefore we carry out internal testing to suggest a reasonable Heat Output Range that the customer should achieve without over firing the unit.

## Eco-Ideal

eco-ideal isn't just a name – it's a statement. We believe that our British landscape is worth protecting. So we designed the eco-ideal range with significantly lower emissions than traditional multi-fuel stoves. Certified by European experts to be exempt from the Clean Air Act, every eco-ideal heater is permissible in Smoke Control areas.

---



## Hunter Living Design

Hunter Stoves are built on over 40 years of expertise – and equipped to face the future. Whichever model you choose, you can now enjoy better performance, more options, and a cleaner future.

---



## Di Lusso

Icona Futuro . . . Designed for designers, the Di Lusso range epitomises smooth Italian chic. It's got the trustworthy performance of a Vespa and the smooth finish of espresso crema. This sleek, flush-to-the-wall stove brings you real flames – in a modern frame.

---



## Avalon

Kick off your shoes and come in... there's a fire flickering behind the glass. An Avalon stove will make your house feel like home.



Your Local Stockist

